



AICA

アイカ

面の“表情”は、空間創造における最も重要な要素の1つだ

同心高光門板【高光面】

材質：純色透心

表面：高光處理

抗菌處理

 4'x 8'x 0.8m/m
垂直板



H8850G



H9908G 褐色心



H9909G 褐色心

同心陶烤門板【消光面】

材質：純色透心

表面：消光處理

抗菌處理

 4'x 8'x 0.8m/m
垂直板



H8850V

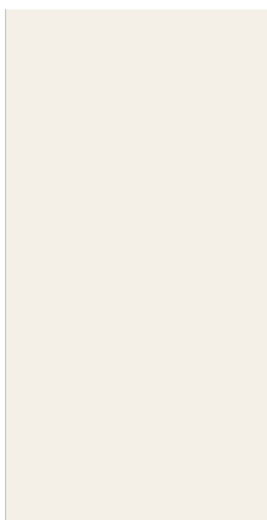

H8851V



H8852V



H8857V

鈦晶門板【耐磨高光抗菌板】

材質：純色透心 表面：抗菌處理、耐磨為一般2.5倍



超級2R Post Form

4'x 8'x 0.8m/m

彎曲板

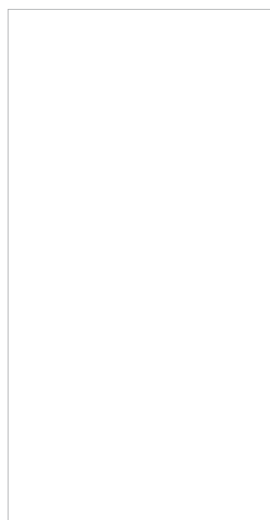

H8801G

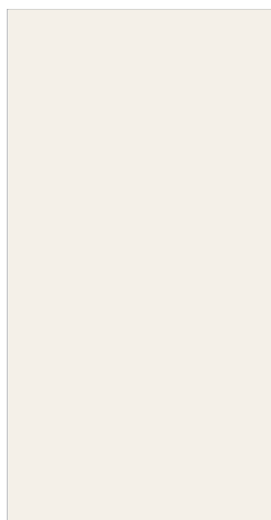

H8802G

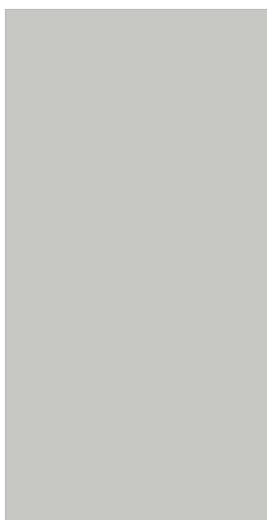

H8803G



H8806G



H8809G

木紋門板【高亮面】抗菌處理



超級2R Post Form
4'x 8'x 0.8m/m 彎曲板



Y7701G



Y7702G



Y7703G



Y7704G



Y7705G



Y7706G



Y7707G



Y7708G



Y7709G

木紋門板【浮雕面】抗菌處理



超級2R Post Form
4'x 8'x 0.8m/m 彎曲板



Y7701H



Y7702H



Y7703H



Y7704S



Y7705S

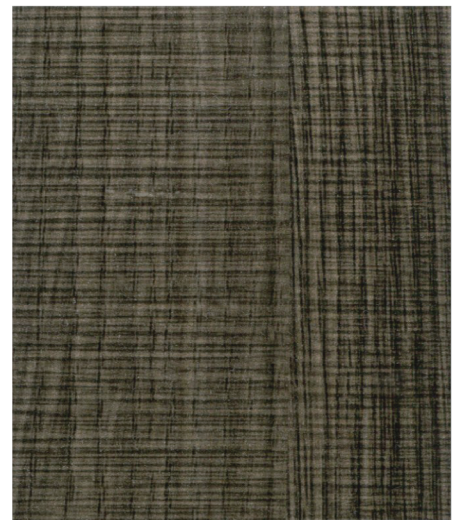

Y7706S



Y7707H



Y7708H



Y7709H

AICA

J型、海灣型、超R角-8A型、四角無線封邊門板

適用：廚具/櫥櫃/浴櫃/門板

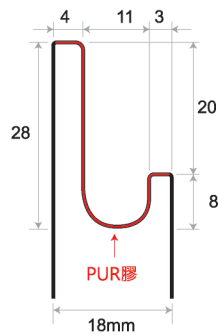

J型門板
木紋門板【浮雕面】x9色
基 材：木芯板
封邊條：同色封邊
背 板：白G美耐板

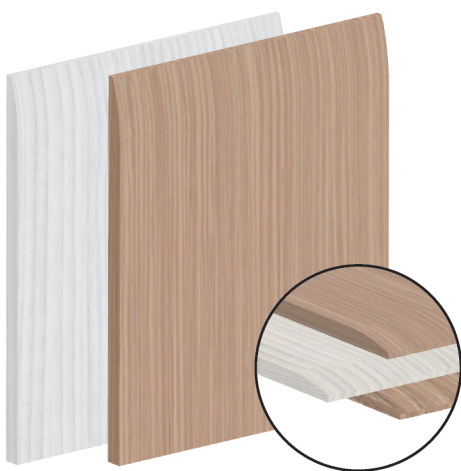

海灣型門板【單灣/雙灣】
海灣型門板
基 材：木芯板
封邊條：同色封邊
背 板：白G美耐板

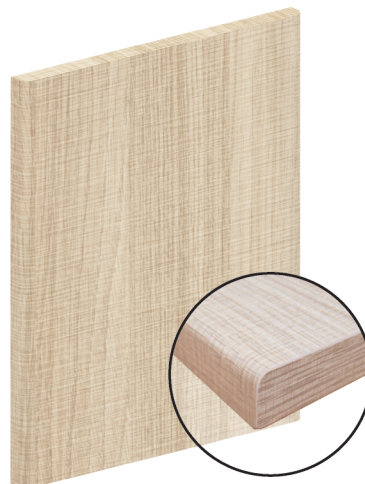

超R角-8A型
鈦晶門板【耐磨高光抗菌板】
基 材：木芯板
封邊條：同色封邊
背 板：白G美耐板
木紋門板【高亮面/浮雕面】
基 材：木芯板
封邊條：同色封邊
背 板：白G美耐板

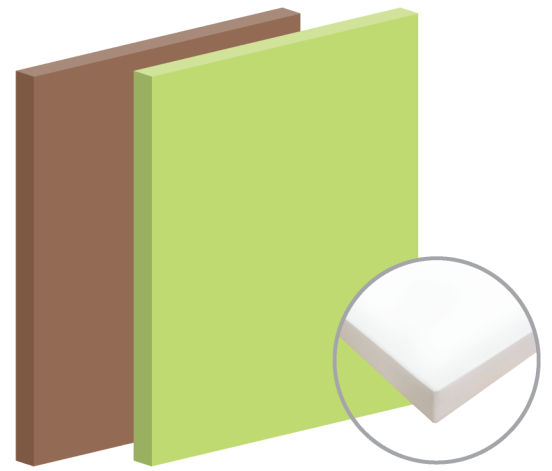

四角無線封邊門板
同心陶烤門板【消光面】
基 材：木芯板
封邊條：同色無線封邊
背 板：純色同心板
同心高光門板【高光面】
基 材：木芯板
封邊條：結晶鋼烤 - 同色無線封邊
背 板：白G美耐板



自然、輝度、深み感

同心高光門板&同心陶烤門板

同心顏色表裡一致，獨特的同紋同質、無縫封邊，融為一體的完美表現。
同心高光門板表面亮麗奪目、晶瑩剔透，精緻高雅無懈可擊。
同心陶烤表面消光處理，雅緻純粹，強調樸實柔和質感，展現溫潤觸感。

鈦晶門板

純色透心、表面清澈立體的光澤，呈現出絢彩震撼的效果。
同色封邊、無縫貼身一體成型，純色實心、表裡一致、鮮艷色彩永保綺麗。
抗菌耐磨表面，阻絕細菌繁殖，抗菌測試榮獲SIAA(工業科技抗菌協會)認證許可。
特殊純白材質，超級小R彎曲角度，配合抗菌耐磨表面處理，無與倫比。

木紋門板

表面近乎天然木皮、多層次的表現，隱約感受到森林的呼喚，有如置身大自然般舒暢無比。
木紋同心門板具天然木紋花色表裡一致，多樣化表面處理，絢麗的高光面大器呈現、
立體質感浮雕面層次豐富、仿真木紋面天然質樸，搭配展現非同凡響的完美質感。

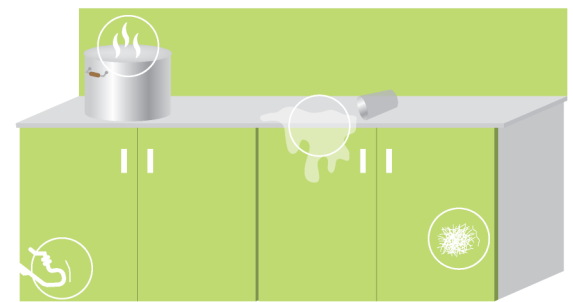

抗菌功能面材處理，門板清潔衛生

※抗菌測試

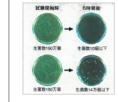

榮獲日本SIAA
工業科技抗菌協會
認證許可

上嵌式鋁封邊把手

※另有其他款式把手可搭配，請參照勝鈔五金目錄

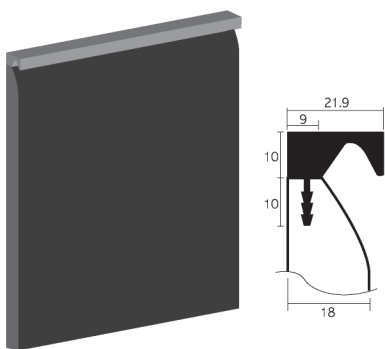

小騎士型/WP-072T(鈦金色)

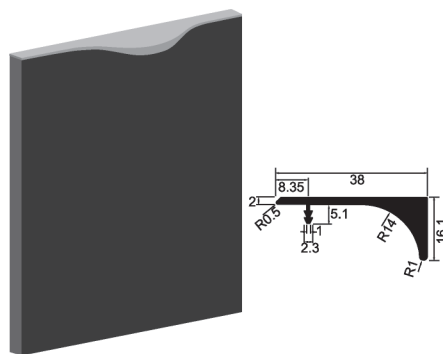

和風型/WP-073(鋁色 / 鈦金色)

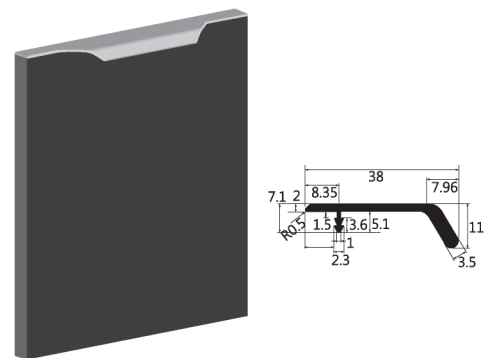
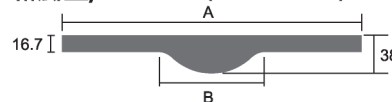

京都型/WP-074(鋁色 / 鈦金色)

